

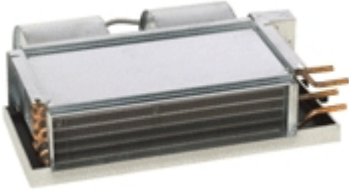

Performance Summary - Unit 8 , FCU



H006DXB301R031

Horizontal Ceiling Concealed (H) - 006, 120/1/60, 3/0 Coil, Right Hand, 3R2C Cool, DX R-410A (H006DXB301R031)

The low profile and flexible design of the Horizontal Basic fan coil is ideal for multiple applications. The slim compact design is well suited for drop-ceiling closet hallway and other concealed applications.

Performance Calculations are at an altitude of 0.00 feet

Fan Performance

Motor Voltage: 120/1/60 Motor Type: Standard

External Static: 0.00 InWC

Airflow at High Speed: 644 cfm

Cooling Coil Performance - 3 rows, 2 circuit, 12 fins/inch

Entering Dry Bulb:	80.00 °F	Leaving Dry Bulb:	54.2 °F
Entering Wet Bulb:	67.00 °F	Leaving Wet Bulb:	54.1 °F
Refrigerant Type:	R-410A		
EAT Dew Point:	60.4 °F	Leaving Fluid Temp:	0.0 °F
		Suction Temp:	45.00 °F
		Total Cooling Capacity:	25,470 BTUH
		Sensible Cooling Capacity:	18,144 BTUH

Electric Heat Performance - 3 kW

Electric Heat Voltage:	120 Volt	Entering Dry Bulb:	70.00 °F
Total Heating Capacity:	10,242 BTUH	Leaving Air Temp:	84.7 °F



Base Unit Summary - Unit 8 , FCU

H006DXB301R031

Horizontal Ceiling Concealed (H) - 006, 120/1/60, 3/0 Coil, Right Hand, 3R2C Cool, DX R-410A
(H006DXB301R031)

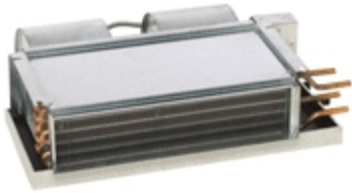

The low profile and flexible design of the Horizontal Basic fan coil is ideal for multiple applications. The slim compact design is well suited for drop-ceiling closet hallway and other concealed applications.

Unit Application - Fan Coil

Cabinet Style (Model) - Horizontal Ceiling Concealed (H)

Unit Size - 006

Sales Program - Standard

System Type - Heat and Cool

System Configuration - DX Cool with Elec Heat

Motor Type - Standard

Motor Voltage/Freq/Phase - 120/1/60

Motor Count - 1

Electric Heat Voltage - 120

Electric Heat kW - 3

Hand - Right

Electrical Hand - Left

Cooling Rows Deep - 3

Cooling Circuiting - 2

Fins Per Inch - 12

Fin/Casing Material - Aluminum/Galvanized

Cooling Coil Connection Size: 1/2

Heating Coil Connection Size: na

Unit Revision Level - B

Circuit Wiring - Single Power Source

Supply - Front Ducted

Return - Open

Wall Type - Single Wall

Insulation - None

Finish - Galvanized

Motor Watts - 216

Drain Pan - Powder Coated Galvanized

Shipping Weight - 157 lbs

Operating Weight - 121 lbs

Valve Summary - Unit 8 , FCU

H006DXB301R031

Horizontal Ceiling Concealed (H) - 006, 120/1/60, 3/0 Coil, Right Hand, 3R2C Cool, DX R-410A
(H006DXB301R031)

Cooling Valve Package

Valve Package Size - None

Valve Actuator - None

Supply Service Fittings - None

Strainer - None

Supply Isolation Valve - None

Coil Connection - Swage

2 & 3-Way Close-Off Pressure - None

Valve Body - None

Water Flow Balancing - None

Fixed Flow GPM - N/A

Return Service Fittings - None

Return Isolation Valve - None

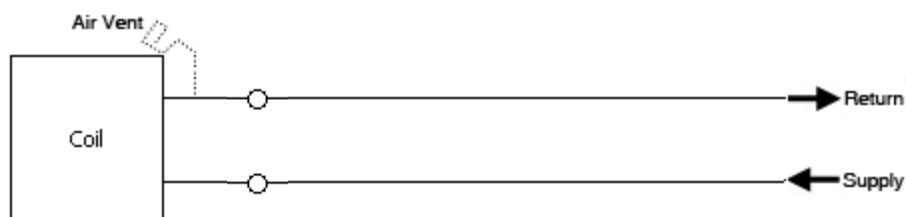



Valve Summary - Unit 8 , FCU

H006DXB301R031

Horizontal Ceiling Concealed (H) - 006, 120/1/60, 3/0 Coil, Right Hand, 3R2C Cool, DX R-410A
(H006DXB301R031)

Heating Valve Package

Valve Package Size - None

Valve Actuator - None

Supply Service Fittings - None

Strainer - None

Supply Isolation Valve - None

Coil Connection - Swage

2 & 3-Way Close-Off Pressure - None

Valve Body - None

Water Flow Balancing - None

Fixed Flow GPM - N/A

Return Service Fittings - None

Return Isolation Valve - None

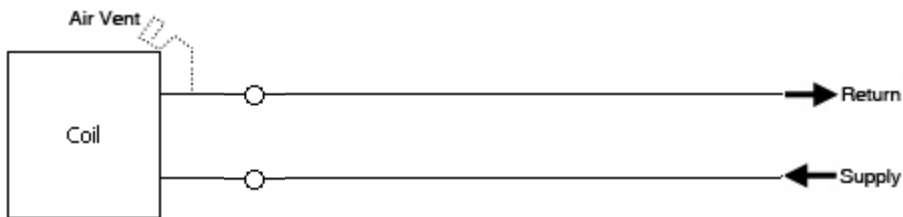



Control Summary - Unit 8 , FCU

H006DXB301R031

Horizontal Ceiling Concealed (H) - 006, 120/1/60, 3/0 Coil, Right Hand, 3R2C Cool, DX R-410A (H006DXB301R031)

Control Voltage - Line Voltage
Thermostat/Humidistat - None
Control Option - Stat By Others
Fan Function - N/A
Pipe Sensor - None
Remote Air Sensor - No
Misc. Options - None

Fan Switch - None
Thermostat Orientation - NA
Terminal Strip - No
Service Switch - No
Circuit Wiring - Single Power Source
Incoming Power Fusing - No
Condensate Float Switch - No

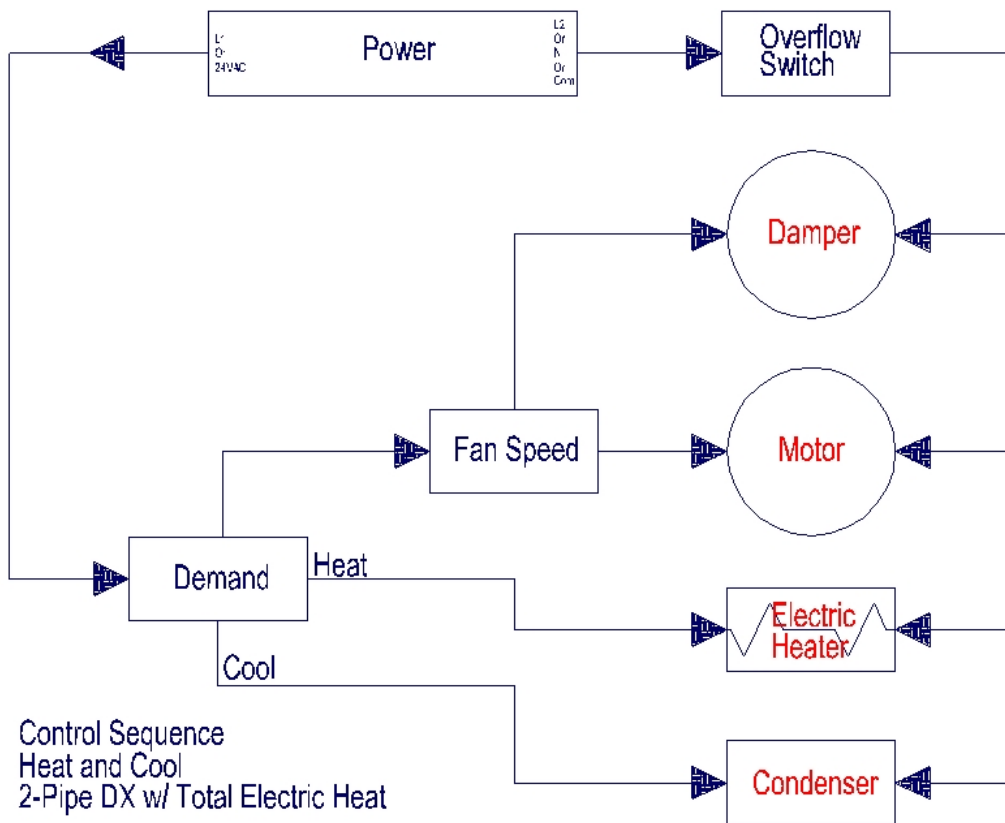

Standard Drawing - Unit 8 , FCU

H006DXB301R031

Horizontal Ceiling Concealed (H) - 006, 120/1/60, 3/0 Coil, Right Hand, 3R2C Cool, DX R-410A (H006DXB301R031)

